

A-A

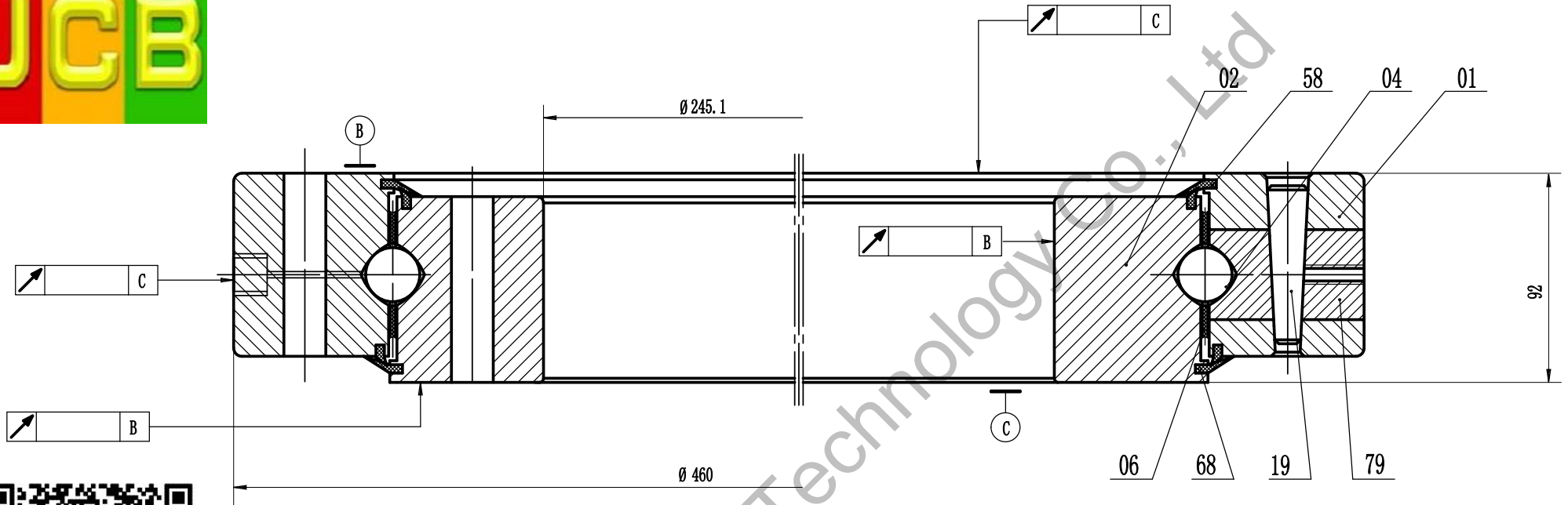

**Remark:**

1. Luoyang JCB Bearing Technology Co., Ltd is a technical Inc, specialize in designing and manufacturing slewing ring bearing, we can design and manufacture all kinds of slewing bearing according to client's requirement.
2. This drawing is reference for user, if you need formal drawing, please contact with us sales@jcb-bearing.com, the official drawing will be submitted after order confirmation.

**Contact information**

Company Address : No.3 Lianmeng road, Luoyang, Henan, China.  
 Postal code : 471003  
 Phone : 86-379-68611678 Fax : 86-379-68611679  
 E-mail: sales@jcb-bearing.com  
 Reserved E-mail: sales@slewing-ring-bearings.com  
 Website: www.jcb-bearing.com  
 www.slewing-ring-bearings.com

58	second seal	1	oil resistant rubber			
68	seal	1	oil resistant rubber			
79	plug	1	steel			
19	taper pin	1	steel			
06	cage		nylon			
04	steel ball		steel			
02	inner ring	1	steel			
01	outer ring	1	steel 50Mn-GB/T699			
No.	name	qty	material	unit	total	
				weight	(kg)	
						90-1B25-0353-0750
						weight(kg)
			four-point contact ball			61
			slewing ring bearing			
				total page	8	page No. 1
				Luoyang JCB Bearing Technology Co., Ltd		